

SPECIFICATION

To manufacture high quality product ,we use ALUMINUM 3005 and PU foam of American DOW with advanced Italian technology.

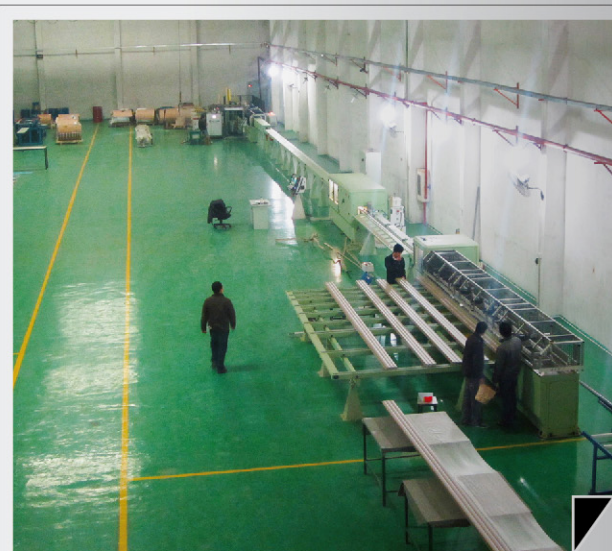
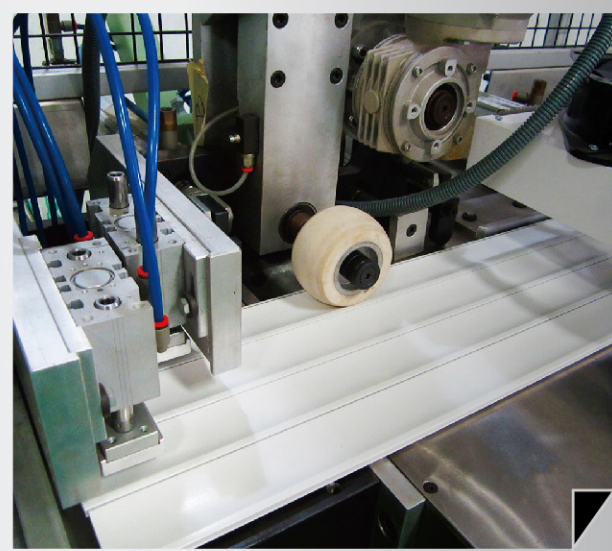

ALR39

Aluminum thickness	0.25mm
PU	Dow
Profile Slat Thickness	8.5mm
Maximun surface Area	8m ²
Weight/Metre,kg	0.086
Weight/m ² ,kg	2.2
Number of Slats/meters	25.6
Standard Length,m	5.8 or 6.0
Quantity per bundle	60 pieces(5 pcs/layer * 12 layers)
Color	White, RAL color can be customized



ALR45

Aluminum thickness	0.25mm
PU	Dow
Profile Slat Thickness	8.7mm
Maximun surface Area	10m ²
Weight/Metre,kg	0.10
Weight/m ² ,kg	2.22
Number of Slats/meters	22.2
Standard Length,m	5.8 or 6.0
Quantity per bundle	40 pieces(4 pcs/layer * 10 layers)
Color	White, RAL color can be customized



ALR55

Aluminum thickness	0.30mm
PU	Dow
Profile Slat Thickness	12.3mm
Maximun surface Area	15m ²
Weight/Metre,kg	0.15
Weight/m ² ,kg	2.73
Number of Slats/meters	18.2
Standard Length,m	5.8 or 6.0
Quantity per bundle	30 pieces(3 pcs/layer * 10 layers)
Color	White, RAL color can be customized

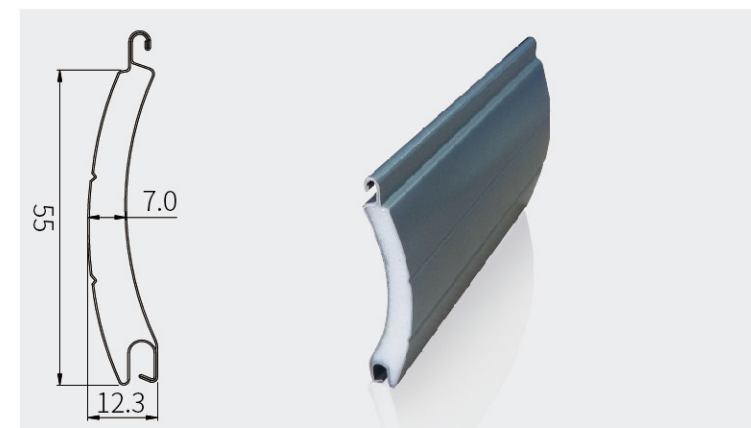

ALR77

Aluminum thickness	0.48mm
PU	Dow
Profile Slat Thickness	18.5mm
Maximun surface Area	16m ²
Weight/Metre,kg	0.36
Weight/m ² ,kg	4.68
Number of Slats/meters	13
Standard Length,m	5.8 or 6.0
Quantity per bundle	10pieces(1 pcs/layer * 10 layers)
Color	White, RAL color can be customized



INSTALLATION METHOD

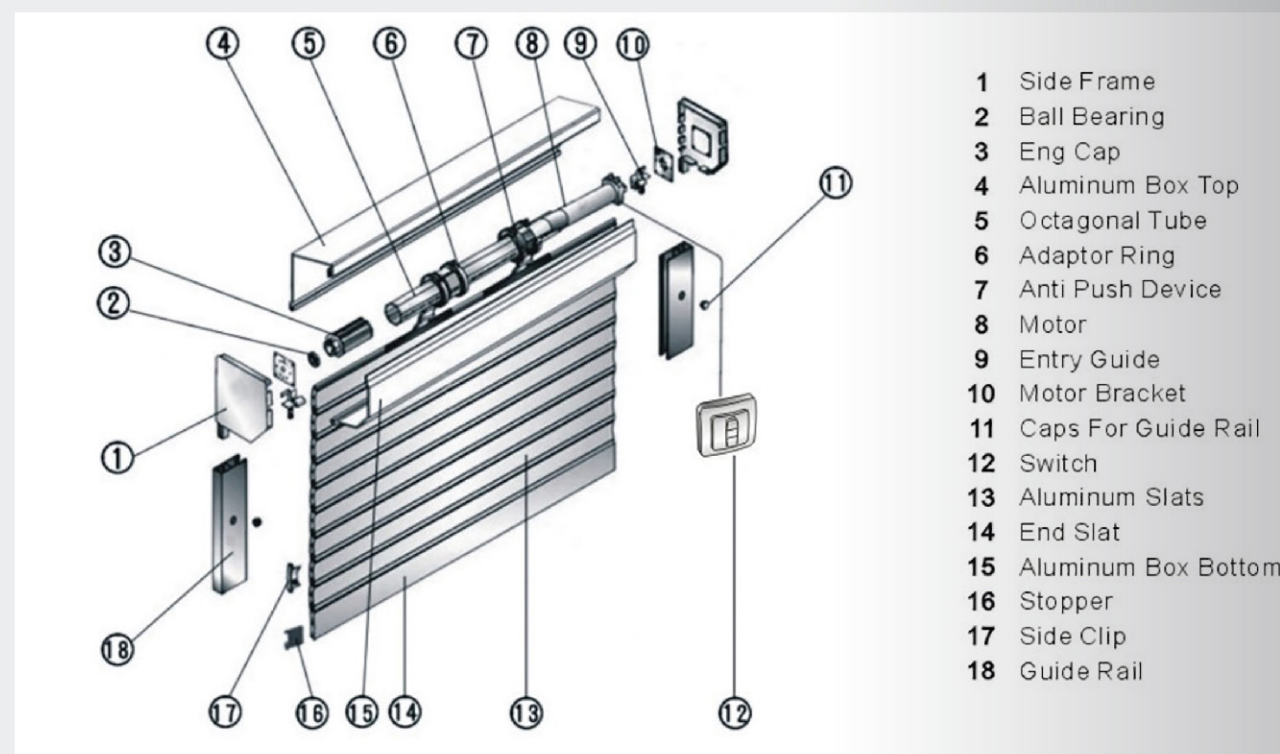

Energy-saving & Thermal Insulation



Security



Privacy Guaranteed



Weather Protection



Mosquito Proof



Sound Insulation



DRIVING METHOD



01 Crank Control System
 Easy operated, crank length is based on the human project
 Maximum coverage: 6m²



02 Strap Control System
 Strap control can be divided into manual strap control and strap winder control.
 Easy and fast operated
 Taking up less space
 Maximum coverage: 3m²



03 Electric control system
 Electric control system can be divided into remote control and switch control
 Easy operated
 Single channel and multi channel for your option



04 Motorized with Crank
 Using manual crank when power cut off.

PACKING

PRODUCT PACKAGING

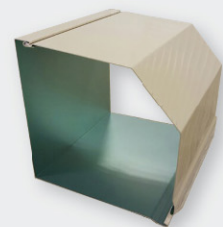

45 DEGREE ALUMINUM BOXES

SIZE	CORRESPONDING SLAT	STANDARD COLOR
150mm	39mm	white
165mm	39&45&55mm	ivory
180mm	45&55mm	silver
205mm	45&55mm	brown
250mm	45&55&77mm	
300mm	77mm	

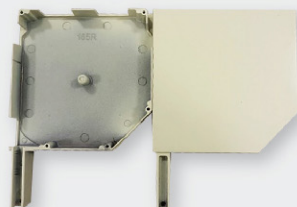

45 DEGREE ALUMINUM SIDE FRAME

SIZE	CORRESPONDING SLAT	STANDARD COLOR
150	39mm	white
165	39&45&55mm	ivory
180	45&55mm	silver
205	45&55mm	brown
250	45&55&77mm	
300	77mm	

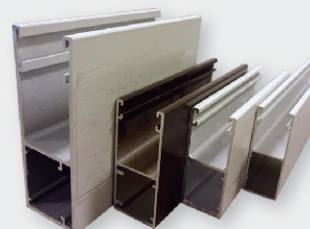

ALUMINUM GUILD RAIL

SIZE	CORRESPONDING SLAT	STANDARD COLOR
19*52mm	39mm	white
22*55mm	45mm	ivory
25*60mm	55mm	silver
25*65mm	55mm	brown
25*72mm	55mm	
34*90mm	77mm	
34*95mm	77mm	



EXTRUDED ALUMINUM ENDSLAT

SIZE	CORRESPONDING SLAT	STANDARD COLOR
7.4*43mm	39mm	white
9*51mm	45mm	ivory
11*53mm	55mm	silver
18.5*77mm	77mm	brown

